



The Eyes of Science

... *i* imagine perfection in digital microscopy



**ECLIPSE**  
**90*i* / 80*i***



Responding to demand, Nikon has developed a series of research-level microscopes that are superbly optimized for digital imaging. Unique “fly-eye” optics and VC-series objectives enable the ECLIPSE 90i and 80i to capture images with excellent resolution and uniform brightness up to the edges. With low-noise fluorescence imaging capability and DIC flexibility, these trailblazing microscopes comprehensively support researchers in the front lines of science.

ECLIPSE  
90i/80i

**Definitive digital imaging . . .  
optimal performance and efficiency**



ECLIPSE 90i—motorized advanced research microscope with seamless PC interface



ECLIPSE 80i—advanced research microscope that grows with your research



# Perfect optics for digital imaging—ECLIPSE 90i and 80i

## “Fly-eye” optics ensure uniform illumination

A revolutionary “fly-eye” lens array built into the main body provides uniform illumination throughout the visual field—perfect for digital imaging.

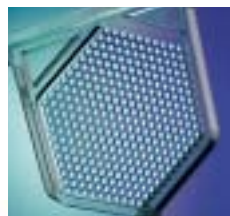

Conception of “fly-eye” optics



Fly-eye lens

Ordinary lens



Viewed with fly-eye lens



Viewed with ordinary lens

## Plan Apo VC objectives deliver high-resolution images, right to the edge

- Shading has been eliminated up to the peripheries to ensure optimum digital-imaging performance.
- Chromatic aberration has also been corrected, even at the h-line (405nm), providing excellent resolution over the whole view field. These objectives are especially suitable for confocal and multi-stained fluorescence microscopy.
- The 60X water immersion objective provides high UV transmittance, even in the 360nm region.



CFI Plan Apo VC 100x Oil, NA 1.40  
CFI Plan Apo VC 60x Oil, NA 1.40  
CFI Plan Apo VC 60x WI, NA 1.20  
CFI Plan Apo VC 20x, NA 0.75

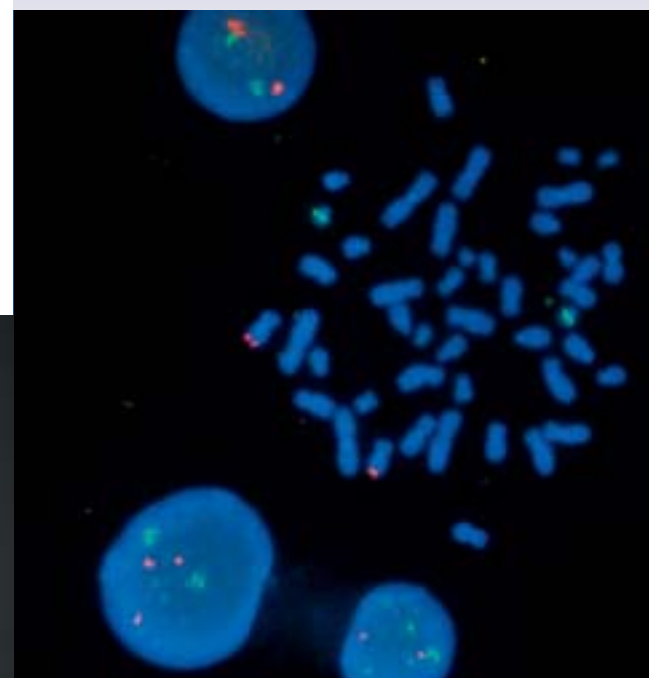

Pictured by Momoki Hirai, Professor, Department of Integrated Biosciences, Graduate School of Frontier Sciences, The University of Tokyo.

## Excellent fluorescence imaging capabilities

To ensure brighter, higher contrast fluorescence images, noise factors have been thoroughly eliminated in the new epi-fluorescence illuminator.

### Noise Terminator boosts S/N ratios

Nikon’s unique Noise Terminator eliminates stray light that causes noise in fluorescence images. You can capture clear, high-contrast images with an S/N ratio five times that of previous models.

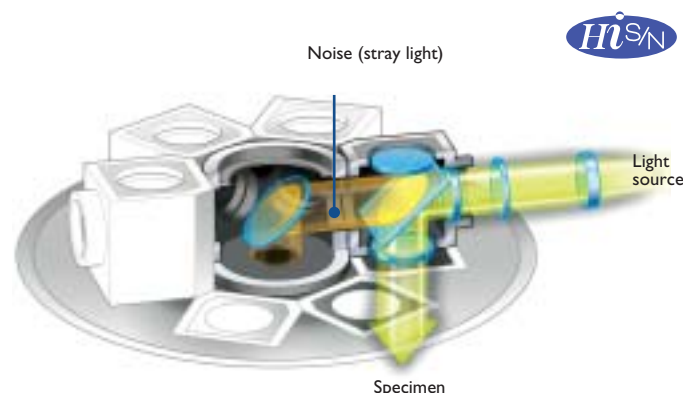

Stray light is thoroughly eliminated from the optical path in the filter turret.

### Excitation Balancer continuously adjusts excitation wavelength (Optional)

The operator can use the Excitation Balancer to continuously change the spectral intensity of each excitation wavelength without changing the filter cube during observations of multistained specimens.



TRITC is emphasized.

DAPI is emphasized.

Standard triple-band excitation is shown.



Excitation wavelength can be adjusted by gradually sliding the excitation balancer.

### Six-filter turret

The filter turret can accommodate up to six filter cubes, and changing them is a breeze. The names and positions of the filter cubes are displayed with phosphorescent labels for easy identification in darkened rooms. The filters or dichroic mirrors in the filter cubes can be easily replaced to create the intended combination.



## Flexible DIC system perfect for individual specimens

- Excellent images with uniform coloration even at low magnification.
- When using dry condensers, you can select from three DIC prism types (best-balanced standard, high contrast, high resolution) to perfectly match individual specimens.
- The shear angle (3D effect) of an image can be adjusted when a rotatable stage is used.

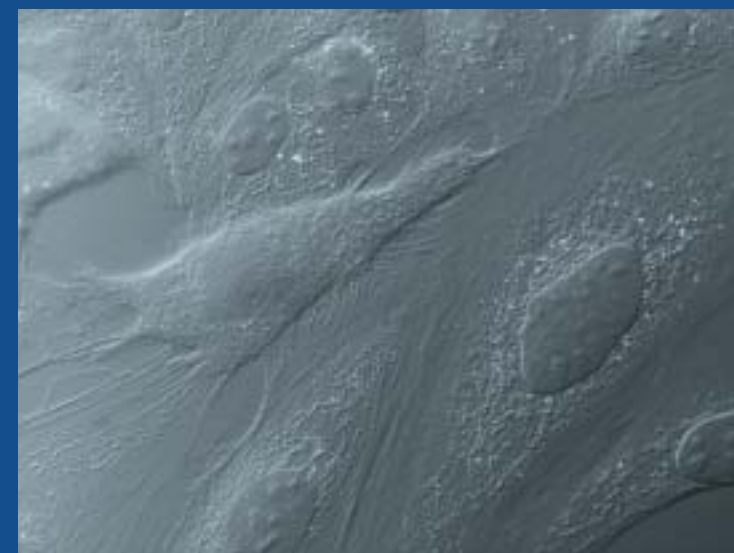

MDCK Cells  
Dr. Shuichi Obata, Kitasato University



# ECLIPSE 90i—motorized model with seamless PC interface For automated observation and imaging

## High-precision motorized focus

Feedback from a linear encoder showing vertical movement enables high-precision focus control in 0.05µm increments, facilitating high-resolution deconvolution, confocal and other techniques.

## Diverse motorized control

### ... from buttons on the 90i main body

The 90i's operating controls and switches are concentrated around the focus knob, enabling smooth observation and imaging while viewing the image.

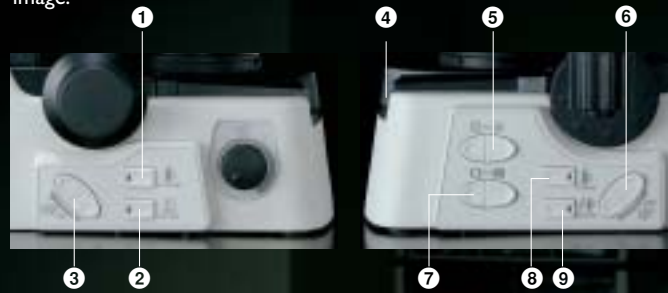

- 1 Coarse/fine/super-fine focus switching
- 2 Refocusing switch (ESCAPE)
- 3 Objective switching
- 4 Optical path switching
- 5 Aperture diaphragm open/close
- 6 Fluorescence filter cube switching
- 7 Field diaphragm open/close
- 8 Coarse/fine/super-fine focus switching
- 9 Excitation light shutter open/close

Note: The allocation of a function to each button can be altered.

### ... with mouse-clicks in the PC monitor GUI

- Microscope-control software, iControl, enables the operator to operate the 90i via mouse clicks on a PC, while displaying microscope status in GUI.
- By remotely controlling the microscope and cameras from a PC outside the darkroom, the microscope is not affected by heat and light generated by the PC.

### ... from camera control unit DS-L2

The 90i can be operated directly from the DS-L2 standalone camera control unit without a PC connection, via the GUI of the built-in LCD monitor.



### ... via Ergo controller

The Ergo Controller comes with an actual stage handle and focus knob, so the stage and focus are controlled seamlessly just like an actual microscope. Also provided are buttons for frequently-used functions, and the allocation of a function to each button can be altered.



## Practical automated observation

### Auto adjustment interacting with the objective changeover

The following settings of each motorized part are automatically optimized for the objective in use:

- Field diaphragm
- Motorized ND filter unit
- Universal condenser aperture diaphragm
- Z-axis travel amount
- Motorized stage travel speed

### One-click switching of observation methods

Switching the observation method, e.g. from DIC to epi-fluorescence, is as easy as clicking on the desired method in the GUI. Setting preferences for each user can be registered.

### Auto link focus

Deviation in parfocal distance is automatically corrected with the change of the objective. This dramatically reduces the time taken for focus adjustments.

### iControl microscope control software

Displays current microscope status in the GUI of the monitor. You can remotely control the motorized units of the 90i by clicking the GUI.



## Efficient automated observation and imaging

In combination with a Digital Sight-series digital camera, it will enhance imaging convenience.

### Auto recording of imaging data

Status data of the microscope, e.g. objective magnification and fluorescence filter in use, is automatically detected. Data can be saved with the image.

### Auto focusing (brightfield)

Auto focusing during brightfield observation is possible utilizing contrast information from the camera.

### Integrated control of microscope and camera

- Major operations of the 90i can be performed with clicks using NIS-Elements imaging software that has been developed to offer total software solutions from image capture, through archiving and analysis to management.
- Time-lapse imaging and Z-axis stack imaging can be easily programmed as microscope and camera are controlled in synchronization.

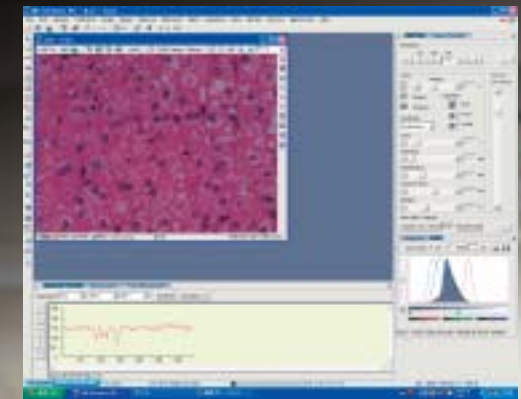

# Customize your own system

The 90i/80i has been developed with emphasis on expandability. You can create the optimum system for your research needs, by freely selecting the microscope, digital-imaging head, and camera system. Motorized sections of the microscope, digital-imaging head and a Digital Sight series digital camera system can be controlled via common application software.



ECLIPSE  
80i

ECLIPSE  
90i

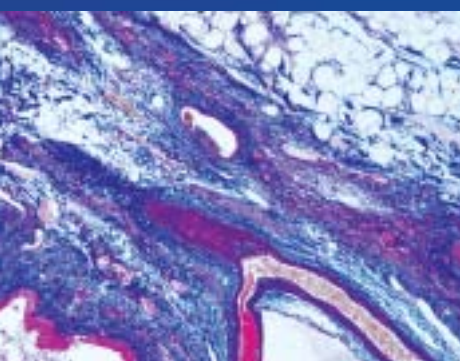

## Microscopes

### ECLIPSE 90i: Motorized model

The focus and field diaphragm have been motorized as standard. Desired sections can be additionally motorized with optional motorized accessories.

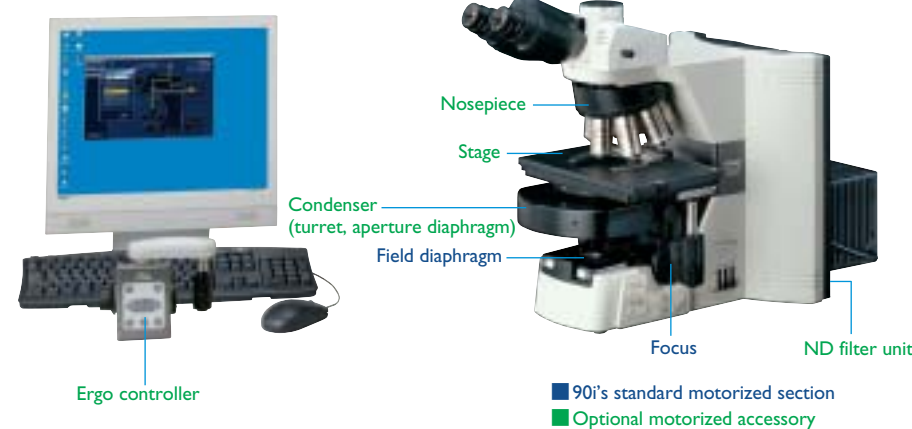

### ECLIPSE 80i: Manual model



## Digital-imaging heads

Both the DIH-E (motorized) and DIH-M (manual) integrate a Hi S/N epi-fluorescence illuminator, binocular tube, dual ports, and optical zoom, into a single unit. This allows signals from each piece of equipment to be centrally controlled, enabling advanced imaging of fluorescence images.

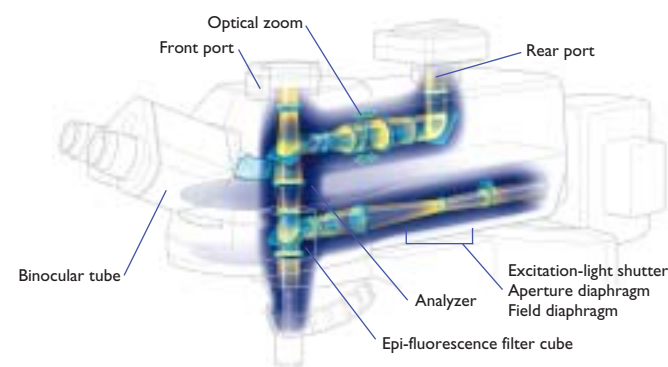

### Simple operation

With the DIH-E model, the following operations have been motorized, and can be controlled from a PC GUI or the Ergo Controller.

- Optical path changeover
- Fluorescence filter changeover
- Excitation light shutter
- Fluorescence field diaphragm
- Optical zoom
- Analyzer

The DIH-M is a manual model, with only the epi-fl shutter motor-controllable with a hand switch.

### Auto recording of status data

When it is combined with a Digital Sight-series digital camera, the status data, such as fluorescence filter in use, and zoom magnification, is automatically recorded as a text file along with the captured image. This feature is extremely convenient for managing the histories of large quantities of images taken under different conditions.

### Optical zoom

The rear camera port is equipped with a 0.8X–2.0X optical zoom to allow digital images to be captured at the desired magnification. Unlike digital zoom, the optical zoom provides high-definition images.

### Dual ports

Two types of cameras can be mounted simultaneously. The front port, in particular, has a design in which the loss of light is minimized, so it is ideal for quantitative analysis or confocal applications.



DIH-E: Motorized model



DIH-M: Manual model (only epi-fl shutter motorized)

# The right answers for all imaging tasks



## Digital Sight series digital camera system

### Auto detection of image capture data

The DS-U2 and DS-L2 automatically detect the status of the 90i/80i\* and the digital-imaging head — including objective magnification, fluorescence filter in use and zoom magnification—and records it simultaneously with image save. This feature is extremely convenient for managing the history log of images taken under different conditions.

\* Objective in use can be detected with the 80i depending on configuration.

### Auto focus function (with 90i)

When configured with the Eclipse 90i for brightfield microscopy, auto focusing is possible utilizing the contrast information provided from the camera.

## Great freedom of choice

You can select the combination best suited to your needs from a wide array of camera heads and control units.

### Ultrahigh-resolution cooled color camera head DS-Ri1

- 12.7-megapixel, 2200TV line high-definition images
- Faithful reproduction of specimen color
- Smooth display of live images
- Reduces heat noise; captures fluorescence and darkfield images clearly



### High-definition cooled color camera head DS-Fi1c

- Cooling mechanism retains CCD at room temperature minus 20°C
- Reduces heat noise. Captures fluorescence and darkfield images clearly
- High-definition 5.0-megapixel color CCD



### High-sensitivity cooled monochrome camera head DS-Qi1

- High sensitivity equivalent to ISO 800
- Cooling mechanism reduces dark current to 0.7e- / pixel/s and readout noise to 8e- rms, realizing a wide dynamic range
- Superior quantity with linearity of >98%



### High-speed color camera head DS-Vi1

- High frame rate, 2.0-megapixel color CCD
- Smooth display of live images. Suitable for monitoring of microscopy images



### High-definition color camera head DS-Fi1

- High-definition 5.0-megapixel color CCD
- High resolution and high frame rate
- High dynamic range and accurate color reproduction
- Reduces noise



### PC-use control unit DS-U2

- Versatile image capture, processing, measurement and analysis when coupled with imaging software NIS-Elements
- High-speed image transfer to PC via USB 2.0 connection
- Compact, space-saving design
- Allows control of Nikon motorized microscopes



### Standalone control unit DS-L2

- Built-in high-definition 8.4-in. large LCD monitor
- Camera can be operated via the GUI of the LCD monitor, eliminating the necessity of PC connection
- Pre-programmed imaging modes for different observation methods
- Allows control of the Nikon motorized microscope 90i



## Confocal microscope A1R/A1 (compatible with 90i only) NEW

The ultimate confocal microscope A1 with high performance and A1R with additional high-speed resonant scanner, provide exceptional image quality and stunning bright images.

- The A1R with a revolutionary hybrid scanner realizes ultrafast and high-resolution imaging. Its high-speed imaging at 420 fps (512 x 32 pixels) allows simultaneous imaging and photo activation.
- High-resolution imaging up to 4096 x 4096 pixels.
- Dichroic mirror with 30% increased fluorescence efficiency provides high image quality.
- Just adding spectral detector, ultrafast spectral acquisition and realtime unmixing is possible. (A1si/A1Rsi system)
- Powerful, intuitive software realizes integrated control of both 90i and A1/A1R system.
- With the VAAS pinhole unit, brighter images with less flare can be acquired. Moreover, different sectioning can be simulated after image acquisition.



## True spectral imaging confocal microscope system C1si

Simultaneous acquisition of 32 channels is possible with one scan. This reduces imaging time and enables the capture of detailed spectral time-lapse images. Accurate and reliable spectral acquisition realizes the observation in true colors.

- One-shot acquisition of a broad 320nm wavelength range.
- Nikon's proprietary polarization control technology and signal processing system greatly reduce signal loss and increase brightness.
- Greatly overlapping wavelengths of fluorescent labels are cleanly separated for images with no spectral crosstalk.
- Wavelength resolution can be set to 2.5nm, 5nm or 10nm.
- Switching between the spectral detector and a standard fluorescence detector is possible.

# A glimpse at typical applications

## Perfect choice for those who want total automation



ECLIPSE 90i configured with the confocal microscopy system A1 and a dedicated digital imaging head.

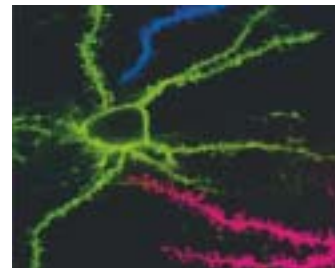

Since processes up to image capture are performed automatically, you can focus more energy on tasks that will follow, such as analysis and research.

- The whole system can be controlled via a PC on the comprehensive GUI.
- Switching observation methods, such as from epi-fluorescence to confocal, can be carried out just at the single click of the mouse.
- The ability to capture images with greater precision in the z-axis direction makes this setup most suitable for confocal and deconvolution applications.
- Timelapse, Z-stack applications are available.
- CFI60 Plan Apo VC objectives are perfect for confocal imaging as axial chromatic aberration has been corrected up to 405nm (h-line).
- A motorized XY stage is also available to complete the motorized system.

## A PC-less manual system, for easy capturing high-contrast fluorescence images



ECLIPSE 80i configured with universal epi-fluorescence illuminator, trinocular tube, and digital camera DS-Fi1c-L2.

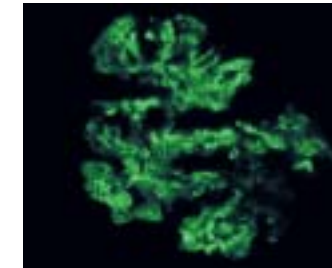

Clear, noiseless fluorescence images are obtainable without a PC.

- The image and microscope settings can be checked on a compact 6.3-inch monitor and saved in a CompactFlash card with one click.
- Images can be easily shared and managed over the network, utilizing the network function of the DS-L2 camera controller.

Pictured by Naoyuki Miyokawa, M.D., Ph.D., Associate Professor, Dept. of Surgical Pathology, Asahikawa Medical College Hospital.

## Motorized control of frequently-used sections



ECLIPSE 80i configured with the motorized digital imaging head DIH-E, and digital camera DS-Fi1c-U2.



If you do not need total automation, desired sections can be partly motorized according to your application by choosing appropriate accessories. For example, a combination of the 80i and motorized DIH-E enables motorized operation only in the part necessary for frequent fluorescence observation.

- The DIH-E and DS-Fi1c can be operated via a common PC software program.
- Image-capture data, such as magnification and the specific protocols used, are automatically detected and saved when the image is captured.
- Low-noise fluorescence images can be captured using the DS-Fi1c cooled CCD digital camera and/or a quantitative monochrome CCD camera.

## For pathology tests and recording of various cases



ECLIPSE 80i configured with ergonomic tube, DSC port, and digital camera DS-Vi1-L2.



A digital-optimized optical system facilitates the capture of high-definition, crisp, clear images in digital format.

- “Fly-eye” lens array optics ensure uniform illumination.
- Ergonomic tube enables natural posture and reduces fatigue during long hours of observation.
- Specimen holder for one slide is also available to facilitate specimen exchange with one hand.
- The DS-Vi1-L2 digital camera is space-saving and enables easy imaging without a PC.

# The most ergonomic system ever ...



## Ergo Controller enables 90i operation in front of a PC

The 90i, digital-imaging head, and a Digital Sight digital camera can be operated via the Ergo Controller. The Ergo Controller, which can be operated as if you are sitting in front of and operating the actual microscope, allows focus adjustment and stage movement\* to be performed while capturing images in front of the PC monitor. The allocation of a function to each button can be altered.

\*When the motorized XY stage is mounted.



## Ergonomic tube

The ergonomic binocular-eyepiece tube can be inclined at angles from 10° to 30° and the eyepieces can be extended up to 40mm. This ensures an optimum eye point and comfortable viewing posture, regardless of the operator's physique or if intermediate modules have been attached.



## DSC port for the ergonomic tube

A C-mount digital camera can be attached to the ergonomic tube. It includes a 0.7X lens that can optimize the frame of the image to be captured to a 2/3-inch CCD.



## Eye-level riser

The eye-level riser can raise the eye-point height in 25mm increments, up to a maximum of 100mm\*, to suit individual requirements.

\*The number of risers that can be used at any one time depends on the tube or intermediate modules being used.



## Stay-in-position stage handle

The handle of the rotatable mechanical stage stays at a fixed position near the focusing knob throughout the full range of X/Y stage movement, so the operator's hand can remain comfortably on the desk at the same position, even when observation points are repeatedly changed. The height- and tension-adjustable stage handle can be set to suit each operator.

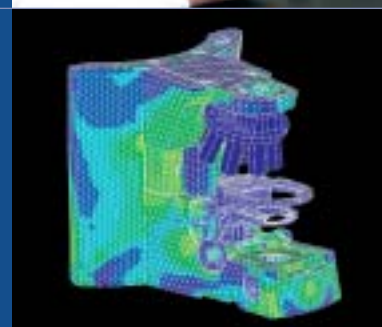

## High-strength body supports comfortable viewing

The stability of the microscope body has been greatly improved to maintain excellent stability and eliminate image shifts during observations at high magnifications. The stage surface has been coated with a smooth, superhard Alumite treatment to protect it from scratches during specimen exchanges.

## Hi S/N epi-fluorescence microscopy



The Noise Terminator eliminates stray light leaking from the filter cube to produce high-contrast images with greater S/N ratios when observing weakly fluorescing specimens. The desired wavelength of a multistained specimen also can be emphasized with the unique Excitation Balancer\*.

\*Optional

## Nomarski DIC microscopy

The new DIC method results in crisp, clear images with perfectly even color, even at low magnifications. Three types of DIC prisms are available to suit the specimen: best-balanced standard, high contrast and high resolution.

## Hi S/N epi-fluorescence/DIC microscopy

Fluorescent-tagged structures or proteins can be located and the cellular morphology of specimens visualized using a high-performance DIC method in combination with Hi S/N epi-fluorescence illumination.

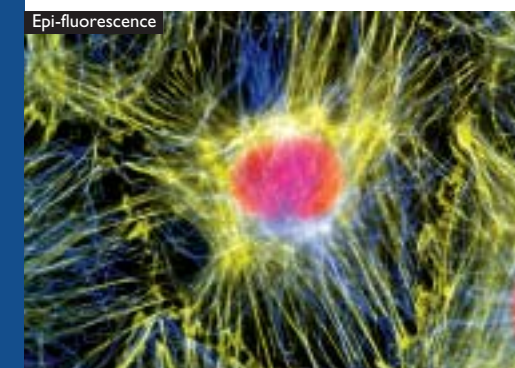

Dr. Torsten Wittmann,  
The Scripps Research Institute.

# ... and outstanding in all microscopy methods

## Phase-contrast microscopy

Nikon has specially developed its unique Apodized Phase Contrast objectives for phase-contrast microscopy. These objectives visualize minute structures—previously difficult to detect due to annoying halos—with excellent contrast and a much wider tonal range. This is ideal for specimens with varied refractive indices.

## Brightfield microscopy

The "fly-eye" lens array in the illumination optics provides uniform brightness to the edge of the view field. The Plan Apo VC objectives provide extraordinarily high resolution over the entire view field. The new 1X-100X condenser visualizes images at any magnifications from ultralow to high, without condenser changes.

## Darkfield microscopy

Nikon's dedicated condensers for darkfield microscopy allow clear observation of blood and the minute structure of flagella. Dry- and oil-type condensers are available.

## Simple polarizing microscopy

Polarizing microscopy is as simple as inserting a polarizer over the field lens and an analyzer in the arm slot. It is ideal for observing birefringent samples such as collagen, amyloids and crystals.

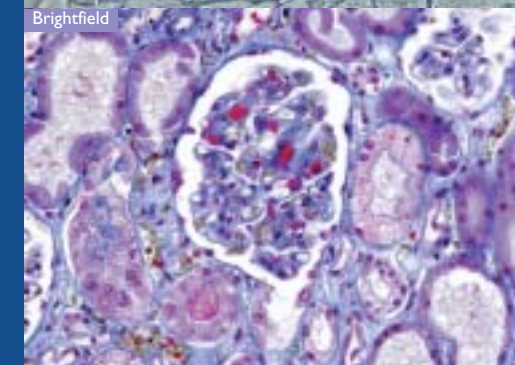
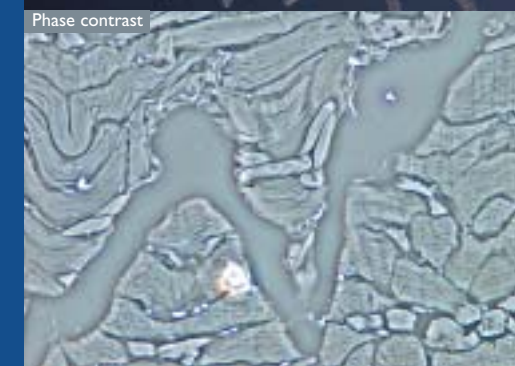

System Diagram

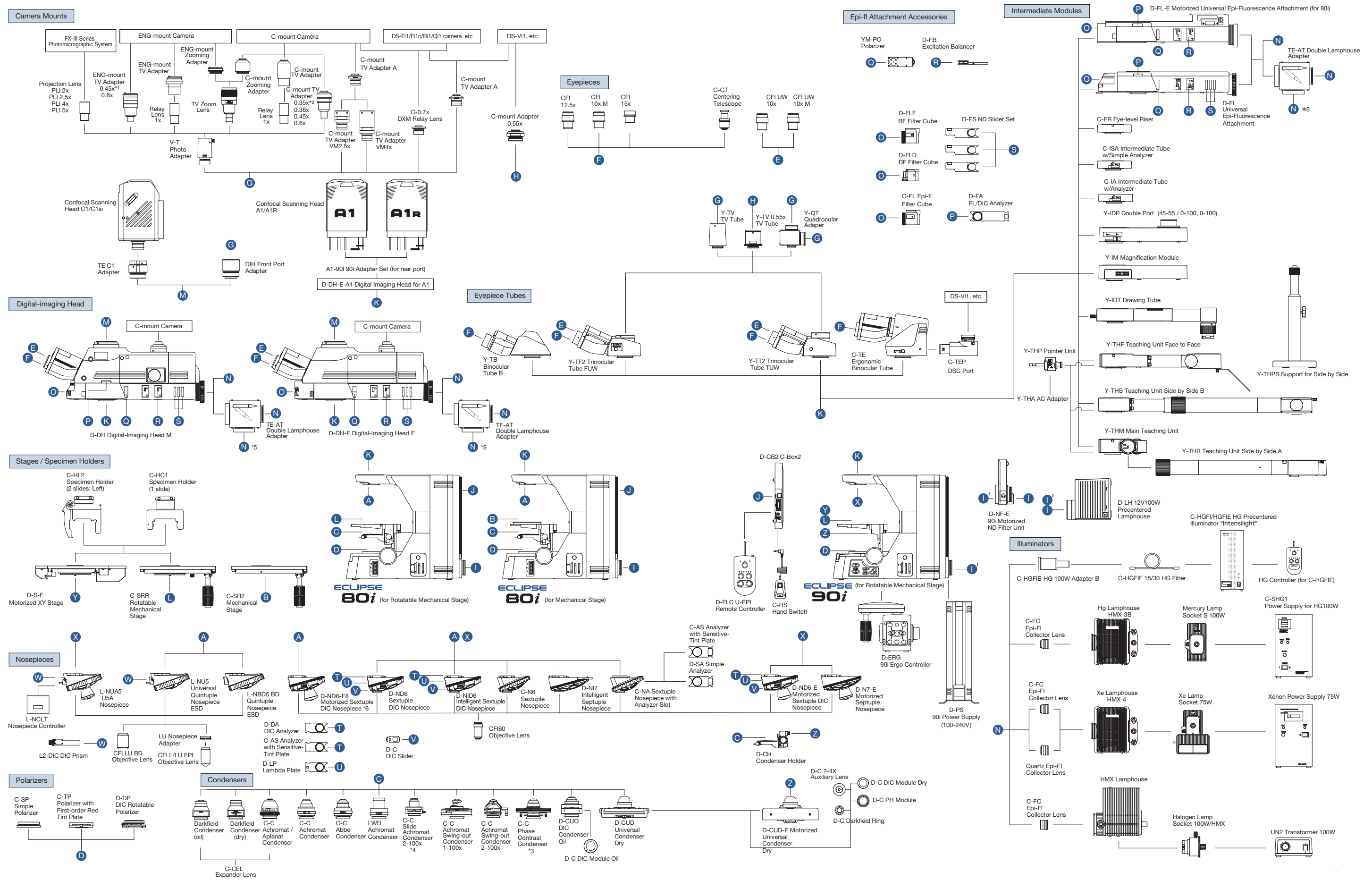

\*1: Use the dedicated 0.45X adapter for the double port sub-port. The 0.6X adapter cannot be used with the double port sub-port.  
 \*2: Use the dedicated 0.35X adapter for the double port sub-port.  
 \*3: Cannot be used with the 90i and 80i models for rotatable mechanical stage.

\*4: Cannot be used with the Achromat/Plan series 4x objective lens.  
 \*5: The Xe lamphouse cannot be attached to the side of the double lamphouse adapter.  
 \*6: Motorized Universal Epi-fluorescence Illuminator is necessary.

Eclipse 90i/80i Specifications

		90i	80i
Main Body	Optical system	CFI60 infinity optical system	
	Base	Rotatable stage model	Mechanical stage model / Rotatable stage model
	Illumination	Precentered 12V100W halogen transmitted illumination Built-in fly-eye lens Built-in NCB11/ ND8/ ND32 filters (detachable) & diffuser (not detachable) Preset switch Motorized field diaphragm External power supply Motorized ND filter unit for light intensity control available as option	Precentered 12V100W halogen transmitted illumination Built-in fly-eye lens Built-in NCB11/ ND8/ ND32 filters (detachable) & diffuser (not detachable) Preset switch Built-in power supply
	Focusing	Motorized coaxial coarse/fine/super-fine focusing Built-in linear encoder, resolution : 0.05um Focusing stroke : 27mm Escape function as refocusing mechanism Auto Link Focus	Manual coaxial coarse/fine focusing Focusing stroke : 27mm Coarse : 14mm/rotation, Fine : 0.1mm/rotation Minimum reading : 1um Refocusing mechanism with focus clamp Coarse motion torque adjustable
Eyepiece Tube (Light distribution)		Y-TB Binocular Tube F.O.V. 22 Y-TF2 Trinocular Tube F.UW F.O.V. 22/25mm (Eyepiece/Port : 100/0, 0/100) Y-TT2 Trinocular Tube T.UW F.O.V. 22/25mm (Eyepiece/Port : 100/0, 20/80, 0/100) C-TE Ergonomic Binocular Tube F.O.V. 22mm inclination angle : 10-30 tube extension up to 40mm (when C-TEP DSC port is attached, Eyepiece/Port : 100/0, 50/50 or 100/0, 0/100) D-DH Digital Imaging Head M / D-DH-E Digital Imaging Head E / D-DH-E-A1 Digital Imaging Head for A1 F.O.V. 22/25mm (Eyepiece/Front Port/Rear Port : 100/0/0, 0/100/0, 0/0/100*) * A 30/0/70 type is also available for DIH-M.	
Eyepiece Lens (F.O.V.)		10X (22mm), 10X M photomask (22mm), 12.5X (16mm), 15X (14.5), UW10X (25mm), UW 10X M photomask (25mm)	
Nosepiece		D-N7-E Motorized Septuple Nosepiece D-ND6-E Motorized Sextuple DIC Nosepiece D-NI7 Intelligent Septuple Nosepiece D-NID6 Intelligent Sextuple DIC Nosepiece C-N Sextuple Nosepiece, D-ND6 Sextuple DIC Nosepiece C-NA Sextuple Nosepiece with Analyzer Slot	
Stage		C-SRR Rotatable Rectangular Mechanical Stage (Centerable, rotation angle 220°) Cross travel 78(X) x 54(Y) mm, with calibrations, stay-in-position stage handle height and torque adjustable D-S-E Motorized XY Stage Cross travel 78(X) x 54(Y) mm, Repeatability: ±10µm C-HC1/HL2 Specimen Holders for 1 slide/2 slides	
Condenser		D-CUD-E Motorized Universal Condenser Dry (Motorized 7-position turret and aperture diaphragm), D-CUD Universal Dry, D-CUO DIC Oil, C-C Abbe, C-C Achromat, C-C Achromat Swing-out 1-100X, C-C Achromat/Aplanat, Darkfield (Dry/Oil), LWD Achromat, C-C Slide Achromat Condenser 2-100x, C-C Achromat Swing-out Condenser 2-100x	
Power Consumption (max.)		100-230V, 2.8A/253W	
Weight (approx.)		18.2 kg (standard trinocular set)	

Digital-imaging Heads, Universal Epi-fluorescence Illuminator Specifications

	DIH-E	DIH-M	DIH-A1	Universal Epi-fluorescence Illuminator	Motorized Universal Epi-fluorescence Illuminator
Applications	Epi-fluorescence, Epi-brightfield, Epi-darkfield, Epi-DIC, Epi-simple polarizing, Confocal				
Light distribution	Observation/front port/rear port: 100/0/0, 0/100/0, 0/0/100	100/0/0, 0/100/0, 0/0/100* * A 30/0/70 type is also available.	Observation/front port/rear port: 100/0/0, 0/100/0, 0/0/100	Depends on eyepiece tube used	
	Motorized switching	Manual switching	Motorized switching		
Optical output ports	Front port: 1X, diameter ø52mm Rear port: optical zoom 0.8-2.0X (continuous), zoom ratio 2.5 : 1, C-mount		Front port: 1X, diameter ø52mm; C1 cannot be mounted Rear port: dedicated for A1/A1R confocal scanner	Not available	
	Motorized	Manual	Motorized		
Inclination angle	25°			Depends on eyepiece tube used	
F.O.V.	22, 25mm				
Filter turret	6 filter cubes mountable				
	Motorized	Manual	Motorized	Manual	Motorized
Hi S/N Noise Terminator mechanism	Available				
Excitation light balancer	Available				
Aperture diaphragm	Centerable, detachable, diameter ø1-9mm (manual)				
Field diaphragm	Centerable, not detachable, diameter ø1-9mm				
	Motorized	Manual	Motorized	Manual	Motorized
ND filters	ND4, ND8, ND16 (manual)				
Excitation light shutter	Motorized			Manual	Motorized
Analyzer	Motorized			Manual (with slot)	Motorized
Polarizer	Manual (with slot)				
Light source	Mercury, xenon, halogen (centerable)				
External connection	USB, C1 interlock, external connection connector		A1 interlock, external connection connector	Not available	USB
Status-check function	Available (data can be recorded with image captured by Digital Sight digital camera)		Not available		Available
Compatible microscopes	90i, 80i		90i	90i, 80i, FN1, ME600L, L150	80i

Dimensional Diagrams

ECLIPSE 90i

Configured with digital-imaging head

Unit: mm

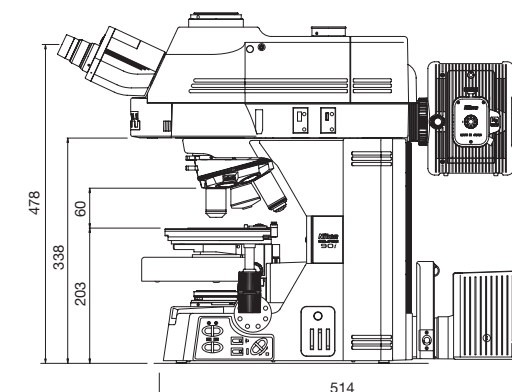
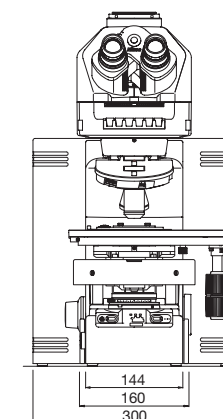

ECLIPSE 80i

Configured with universal epi-fluorescence illuminator and ergonomic binocular tube

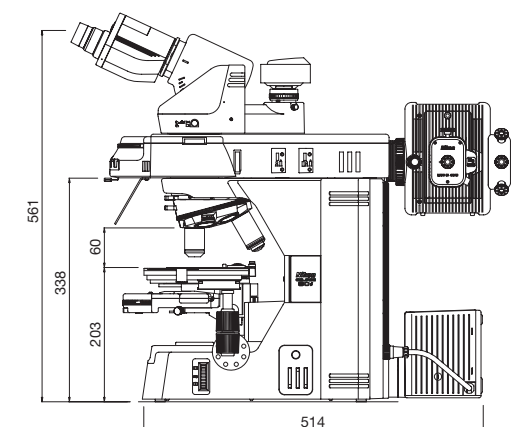
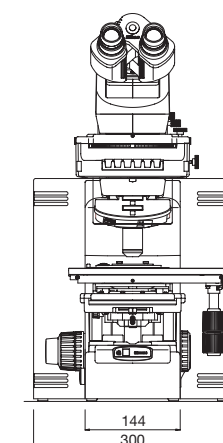

Configured with TUW trinocular tube

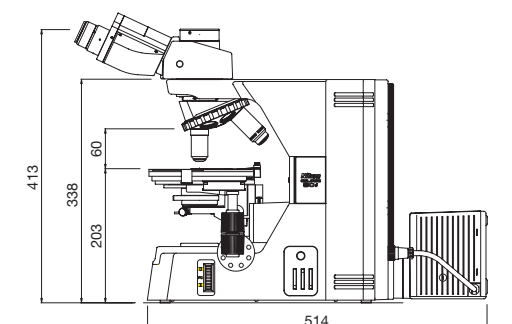
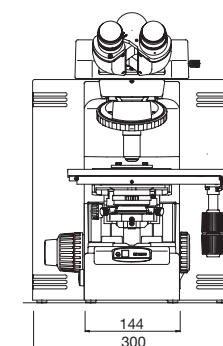

*Nikon has reduced the amount of chromium, cadmium and lead used in the Eclipse-i Series to an absolute minimum to diminish its environmental impact.*

Please contact Nikon for a handy pamphlet listing compatible accessories, including objectives and epi-fluorescence filters.

Specifications and equipment are subject to change without any notice or obligation on the part of the manufacturer. March 2010 ©2004-10 NIKON CORPORATION

 **WARNING** TO ENSURE CORRECT USAGE, READ THE CORRESPONDING MANUALS CAREFULLY BEFORE USING YOUR EQUIPMENT.

\* Monitor images are simulated.  
Company names and product names appearing in this brochure are their registered trademarks or trademarks.



#### NIKON CORPORATION

Shin-Yurakucho Bldg., 12-1, Yurakucho 1-chome, Chiyoda-ku, Tokyo 100-8331, Japan  
phone: +81-3-3216-2375 fax: +81-3-3216-2385  
<http://www.nikon.com/instruments/>

#### NIKON INSTRUMENTS INC.

1300 Walt Whitman Road, Melville, N.Y. 11747-3064, U.S.A.  
phone: +1-631-547-8500; +1-800-52-NIKON (within the U.S.A. only)  
fax: +1-631-547-0306

<http://www.nikoninstruments.com/>

#### NIKON INSTRUMENTS EUROPE B.V.

Laan van Kronenburg 2, 1183 AS Amstelveen, The Netherlands  
phone: +31-20-44-96-300 fax: +31-20-44-96-298

<http://www.nikoninstruments.eu/>

#### NIKON INSTRUMENTS (SHANGHAI) CO., LTD.

CHINA phone: +86-21-5836-0050 fax: +86-21-5836-0030  
(Beijing branch) phone: +86-10-5869-2255 fax: +86-10-5869-2277  
(Guangzhou branch) phone: +86-20-3882-0552 fax: +86-20-3882-0580

#### NIKON SINGAPORE PTE LTD

SINGAPORE phone: +65-6559-3618 fax: +65-6559-3668

#### NIKON MALAYSIA SDN. BHD.

MALAYSIA phone: +60-3-7809-3688 fax: +60-3-7809-3633

#### NIKON INSTRUMENTS KOREA CO., LTD.

KOREA phone: +82-2-2186-8410 fax: +82-2-555-4415

#### NIKON CANADA INC.

CANADA phone: +1-905-602-9676 fax: +1-905-602-9953

#### NIKON FRANCE S.A.S.

FRANCE phone: +33-1-4516-45-16 fax: +33-1-4516-45-55

#### NIKON GMBH

GERMANY phone: +49-211-941-42-20 fax: +49-211-941-43-22

#### NIKON INSTRUMENTS S.p.A.

ITALY phone: +39-055-300-96-01 fax: +39-055-30-09-93

#### NIKON AG

SWITZERLAND phone: +41-43-277-28-67 fax: +41-43-277-28-61

#### NIKON UK LTD.

UNITED KINGDOM phone: +44-208-247-1717 fax: +44-208-541-4584

#### NIKON GMBH AUSTRIA

AUSTRIA phone: +43-1-972-6111-00 fax: +43-1-972-6111-40

#### NIKON BELUX

BELGIUM phone: +32-2-705-56-65 fax: +32-2-726-66-45