



ECLIPSE FN1

Fixed Stage Microscope for Electrophysiological Research

*Introducing the world's
first automated patch
clamp system!*

State-of-the-art Research Microscope Optimized for Observation and Analysis of in Vivo/in Vitro Nervous Activity

ECLIPSE FN1

Fixed Stage Microscope for Electrophysiological Research

The Eclipse FN1 is a special purpose upright microscope developed to meet the rigorous demands of electrophysiological research. Never before has an electrophysiological microscope enabled visualization of minute details deep within a specimen with such clarity and contrast. The FN1 has a completely redesigned optical system that includes the world's first water dipping objective with depth-induced aberration correction. The innovative new motorized Multi Patch System allows multipoint patch-clamp experiments to be conducted easily, greatly enhancing the efficiency of advanced research. Moreover, in combination with the new multiphoton confocal microscope system A1R MP, high sensitivity deep in-vivo confocal images can be acquired at high speed.



Configuration with Narishige stage

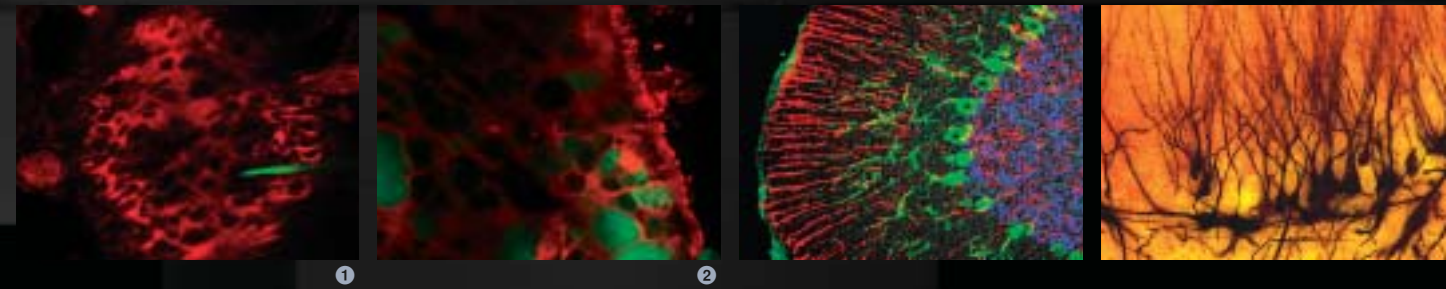

The World's First! Automated Multi Patch System

By simply adding this system to the FN1, operations to change the field of view and magnification are motorized. With the addition of dedicated motorized manipulators, electrodes can be automatically moved to pre-selected cells of interest in multiple fields of view.

(▶ See page 8)



Configuration with Sutter Instrument components



Configuration with EXFO stage



Configuration with Nikon stage



Variable magnification double port

16x objective

New Objective Lenses Allow Imaging of Deeper Areas with Ultimate Clarity

The true one-lens solution: LWD 16x objective

By using a variable magnification double port (optional), the 16x objective allows you to capture images from a low magnification wide field at 5.6x to a high magnification high resolution at 64x with the rear port CCD camera*¹ with the same lens. A wide viewfield of up to 2.0mm can be achieved at 0.35x intermediate magnification, enabling the observation of whole specimens and easy electrode placement. Variable magnification double port varies magnification between three levels (0.35x/2x/4x or 0.35x/1x/4x*²).

*Magnification of the front port is not variable.
*²0.35x/1x/4x type will be released soon.



5.6x (magnification 0.35x)



32x (magnification 2x)



64x (magnification 4x)

Images courtesy of: Dr. Hiroyoshi Miyakawa, Dr. Shigeo Watanabe, Tokyo University of Pharmacy and Life Science



As the 16x objective has a wide 45° manipulator approach angle and 3.0mm long working distance.

The world's first water dipping objective with depth-induced aberration correction

The Plan 100xW objective (NA 1.1, W.D. 2.5mm) is the world's first water dipping lens with a correction ring. This ring corrects spherical aberration induced by imaging deep in tissue or by working at physiological temperatures — providing outstanding Z-axis resolution in IR-DIC imaging, as well as a tight point spread function for confocal applications. With excellent IR transmission, this lens is a terrific choice for Multi-Photon imaging.

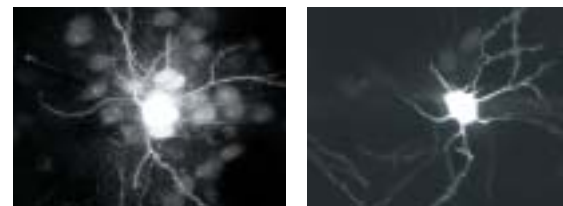

Images courtesy of: Hiroyuki Hakozaki MS, University of California, San Diego

New objective series — ideal for IR-DIC imaging

Axial chromatic aberration in the visible to near-infrared region (up to 850nm) has been corrected in CFI APO 40xW NIR and 60xW NIR objectives. This enables the user to observe/document minute structures of a thick specimen with ample resolution. In addition, transmittance of every objective is exceptionally high, even in the IR region, thanks to wide-range spectrum anti-reflection coatings.



Easy insertion of microelectrode

The objectives boast a long W.D. of 2.5-3.5mm (2.5mm even at 60x or 100x), taking advantage of the 60mm parfocal distance of the CFI60 optics. Since there is ample space above the specimen, microelectrodes can be easily inserted. The diameters of the objectives are 17% slimmer than previous lenses, and provide broad approach angles up to 45°, facilitating dramatically enhanced access of microelectrodes to the specimen.

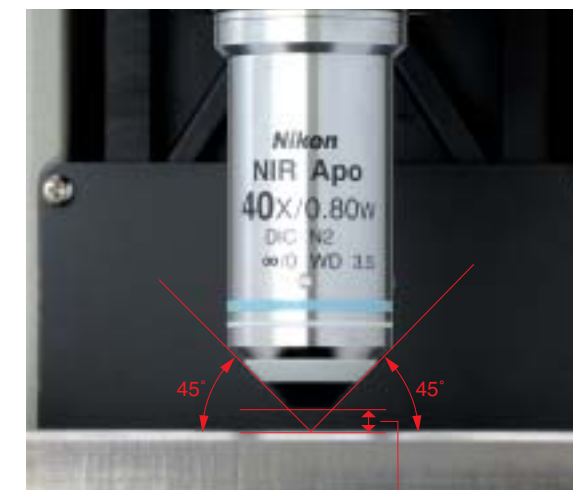

45° approach angle, long working distance



Water dipping objective CFI Plan 100xW
Water dipping objective CFI75 LWD 16xW



Streamlined Electrophysiological Experiments and Broad Work Space

Smoother objectives changeover

The FN1 comes with a 2-position sliding nosepiece. A high magnification objective can be mounted on either the front or back position.

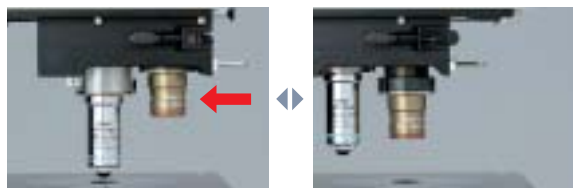

Front/back sliding objective changeover

The objectives can be raised by the lever to prevent collision with the manipulator or the chamber when they are being changed. The retraction distance is 15mm, so even a thick glass dish is protected.

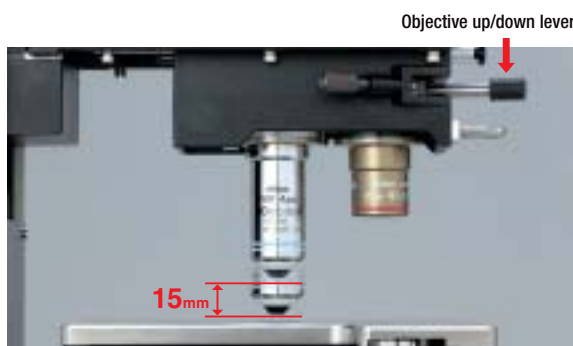

Objective retraction mechanism

Parfocal distance correction and centering mechanism

The parfocal distance of both the front and rear objectives can be finely tuned to achieve perfect parfocality. The front objective has a centering mechanism, which ensures perfect parcentricity, making it simple to find your cell when switching to a higher magnification.

Parfocal distance correction knob



Safe, accurate dipping operation

After the objective has been lowered, it can be further lowered by approximately 1mm by depressing the lens up/down lever to gently dip the lens top into the bath solution. This eliminates the risk of specimen disturbance due to the lowering of the objective deep into the solution.

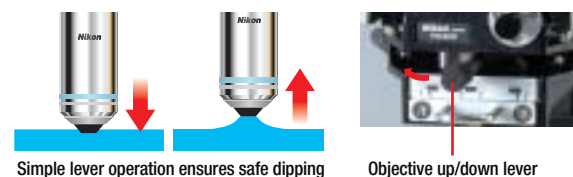

Simple lever operation ensures safe dipping

Objective up/down lever

Simple wavelength/illumination switchover

Alternating wavelength from visible to IR (infrared), or illumination technique from DIC and Oblique Light is carried out simply by rotating the wavelength selection and illumination selection turrets. Oblique illumination provides high contrast with deeper shadows by providing incident illumination at shallow angles.



Observed under oblique illumination

Observed under IR-DIC illumination

Images courtesy of: Dr. Hiroyoshi Miyakawa, Dr. Shigeo Watanabe, Tokyo University of Pharmacy and Life Science



Illumination selection turret

The user can choose between DIC illumination and oblique illumination. The oblique illumination direction can be freely adjusted by rotating the incident illumination 360°, making it easy to identify the microelectrode position.

Wavelength selection turret

The user can choose from IR-DIC, visible DIC and brightfield. Deeper tissue penetration into a specimen can be clearly visualized by choosing infrared wavelengths between 850 and 950nm.

Waterproof LWD condenser with increased flexibility

Nikon has developed a new LWD condenser that can easily be switched between brightfield, DIC, and Oblique Light illumination techniques by simply rotating the turret. The new condenser has a long working distance, providing a wide space between it and the specimen. In addition, the condenser surface is waterproof and comes with a solution reservoir to catch spills. The condenser can be easily removed — even if you are using a fixed stage — and it can be cleaned without causing vibration to the manipulator.



The condenser and polarizer turret can be simply and quickly removed.

Streamlined operation

The focus knob and field diaphragm adjustment are located on the front part of the base to enable efficient focusing. Moreover, there are no cumbersome belts outside the base. The coarse/fine focus knob is located on both the left and right sides, so it can be operated with either hand. In addition, the optional remote handle enables ON/OFF and light intensity adjustment of the fiber illumination from outside the cage.



I-shaped slimline body creates more space above and below the stage

The simple and slim I-shaped body has no projection on the body other than the focus knob, so there is more space in the working area for your experiment. This also provides better access around the microscope to position manipulators and other peripherals. With the eye-point of the body 25mm lower than conventional models, you can work in greater comfort.



The World's First Automated System to Enable Observation of Multiple Fields of View without Moving the Objective or Specimen

Nikon has developed the Multi Patch System, a revolutionary new motorized accessory for patch-clamp experiments. The system employs an innovative mechanism that allows viewfield changeover without moving the objective or specimen. When used in combination with the wide viewfield 16x objective and Sutter Instrument's optional motorized manipulators, it is possible to move electrodes automatically in conjunction with the viewfield changeover.



Configuration with Multi Patch System and Sutter Instrument components

Motorized viewfield changeover without moving the objective or specimen (patent pending)

By swinging the optical path of the objective with the precisely controlled tilting mirror mechanism incorporated in the newly developed motorized tilting mirror unit, the viewfield can be freely moved in a square of up to $1000\mu\text{m} \times 1000\mu\text{m}$. As the objective is not moved when the viewfield is changed, there is no possibility of contact with the electrode.

It is also possible to store areas of interest in the memory and change the viewfield instantly with a single mouse-click.

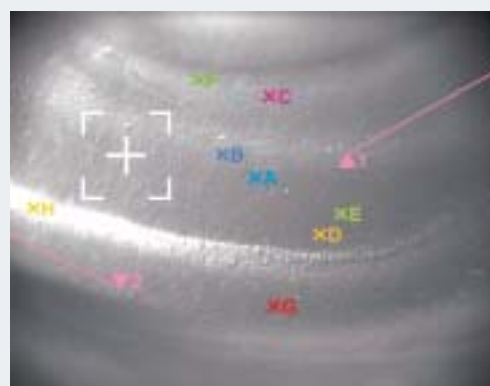

"Bird's-Eye View" allows observation within wide field of view of multiple pre-selected cells of interest at a glance.

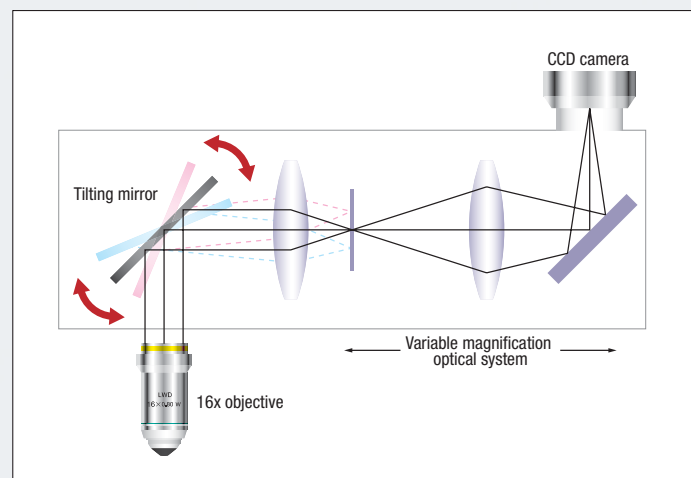

Motorized tilting mirror unit

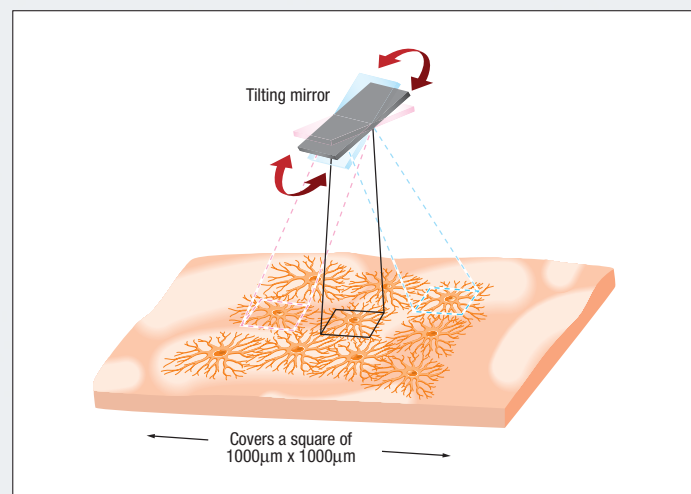

Viewfield is moved by swinging the optical path

Coupled control of viewfield and manipulator (patent pending)

The dedicated software detects the position of the microscope's viewfield and controls the Sutter Instrument motorized manipulator in conjunction with the viewfield changeover.

- **Electrode moves to the point of interest [Move mode]**

Because the microscope and manipulator share the XYZ coordinate system, the motorized manipulator automatically moves the electrode in both XY (horizontal) and Z (vertical) directions in conjunction with the viewfield moving to the saved point. (Up to 8 points can be stored; up to four manipulators mountable.)

- **Electrode follows viewfield changeover [Synchro mode]**

The electrode automatically tracks changes in field of view.

- **Prevention of electrode damage**

The software constantly monitors the positions of the electrodes to avoid any unwanted electrode collisions. When there is a possibility of contact, it automatically halts the manipulator and warns the user, preventing electrode damage and enabling safe, efficient experiments.

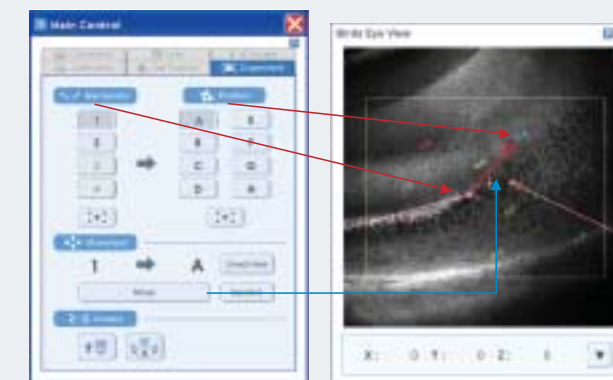

Main control screen

Bird's-eye view screen

1. Specify the electrode to be moved
2. Specify point stored in memory
3. Click "move" button

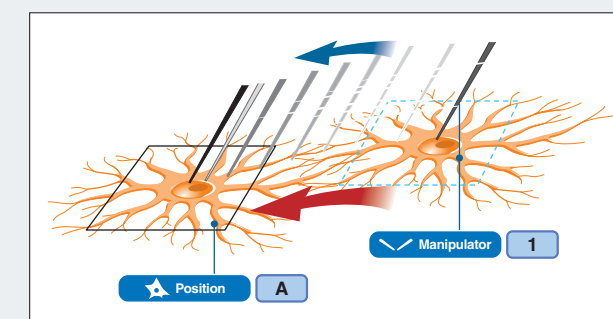

Electrode moves in conjunction with changes in viewfield

Motorized magnification changeover between three levels

The variable magnification optical system incorporated in the motorized tilting mirror unit enables motorized magnification changeover between 0.35x, 2x and 4x. One 16x/0.8 NA objective flexibly covers images from low magnification wide field to high magnification high resolution. Wide 2.0mm viewfield is assured at 0.35x magnification, enabling easy positioning and replacement of electrode.

Images courtesy of: Dr. Hiroyoshi Miyakawa, Dr. Shigeo Watanabe, Tokyo University of Pharmacy and Life Science

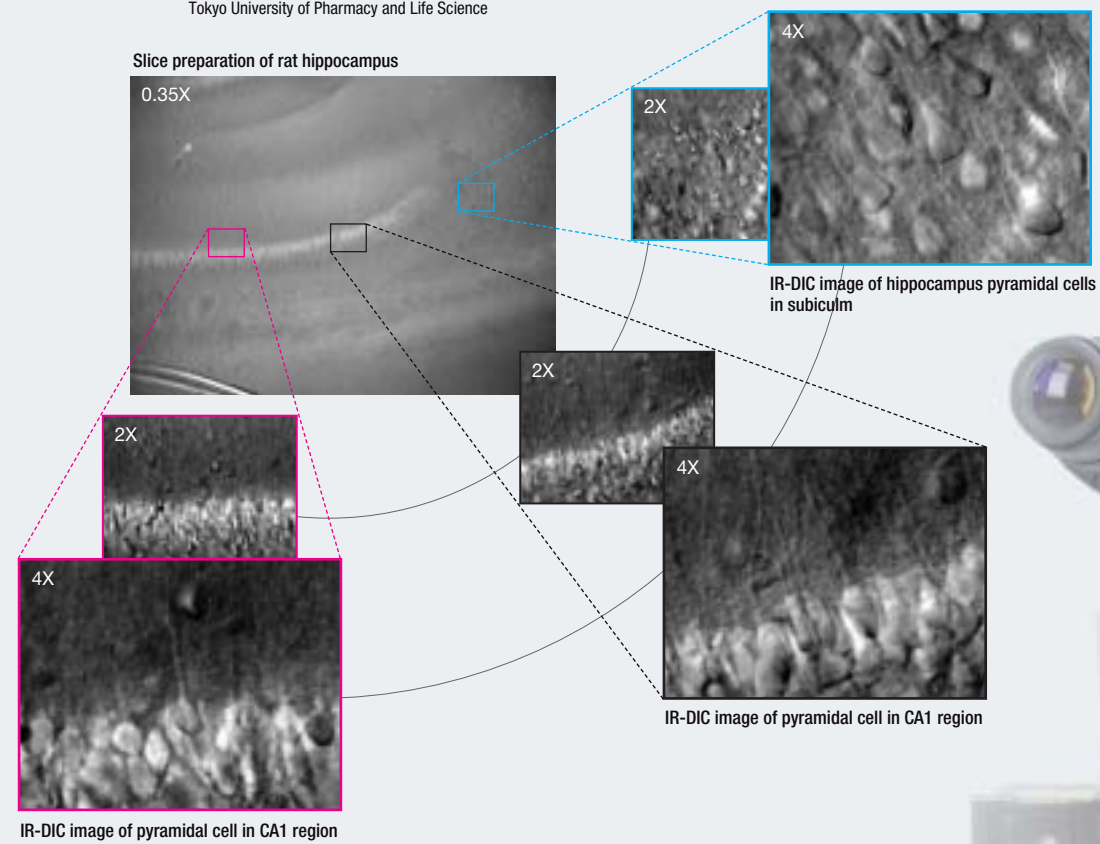

IR-DIC image of pyramidal cell in CA1 region

Easy-to-use dedicated software

This software allows control of the motorized tilting mirror unit and motorized manipulator, as well as confirmation of the state of the IR-CCD camera with intuitive GUI. Programmed control of multipoint patch-clamp experiments is also possible. The low magnification bird's-eye view clearly shows coordinate positions of the viewfield and electrode. The image capture function makes it possible to record images in conjunction with the movement of the electrodes and the viewfield.

GUI screen

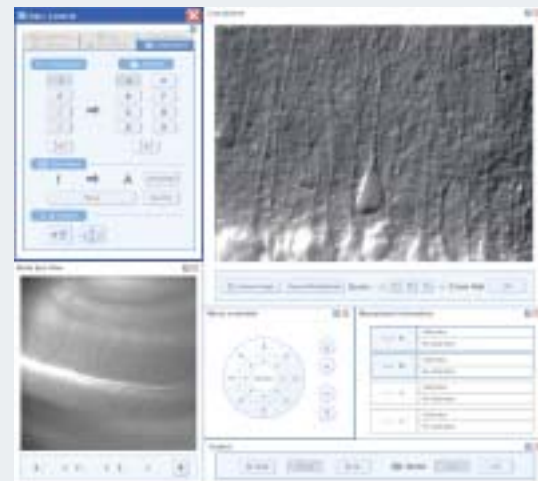

Live view allows observation of electrode tips



The live image is displayed in the "live picture" window and desired images can be stored as still images. Moreover, it is possible to display up to 192x zoomed images by combining digital zoom up to 3x and optical magnification.

Ergo controller

The new dedicated ergo controller enables operations such as viewfield movement and magnification changeover with the operational feel of an actual microscope.



Multi Patch System

Compatible optical system	CFI75 infinity optical system
Compatible microscope	FN1 (fixed stage microscope)
Nosepiece	FN-MN-N Single Objective Holder (for CFI75 objective) 1-position; DIC prism attachable
Objectives	CFI75 LWD 16xW NA: 0.8, W.D.: 3.0
Device magnification	Front port: 1x Rear port: 4x, 2x, 0.35x
F.N.	Front port: 22 Rear port: 11
Magnification changeover	Motorized (control by FN ergo controller or dedicated software)
Viewfield move	X: $\pm 500\mu\text{m}$, Y: $\pm 500\mu\text{m}$ Minimum stroke: 0.005mm (actual field of view) Position accuracy: $\pm 0.01\text{mm/hour}$ or better (actual field of view) Position repeatability: within $\pm 0.01\text{mm}$ (actual field of view, default position/stored position)
Optical path changeover	Manual dial (front port/rear port)
Analyzer	Manual slider (rear port only)
Recommended CCD size	2/3-inch (rear port)
FN ergo controller functions	Viewfield movement (in XY directions), revert to viewfield center, storage/revert of observation point, magnification changeover, halt of power supply
Operating conditions	Temperature: $+10^\circ\text{C}$ to $+40^\circ\text{C}$ Humidity: 85%RH max. (no condensation)
Dimensions and weight	Motorized tilting mirror unit: 184 (W) x 80.5 (H) x 341 (D)mm, 3.3kg FN ergo controller: 129 (W) x 160 (H) x 140 (D)mm, 2.3kg Relay box: 195 (W) x 63 (H) x 31 (D)mm, 0.47kg

System Diagram

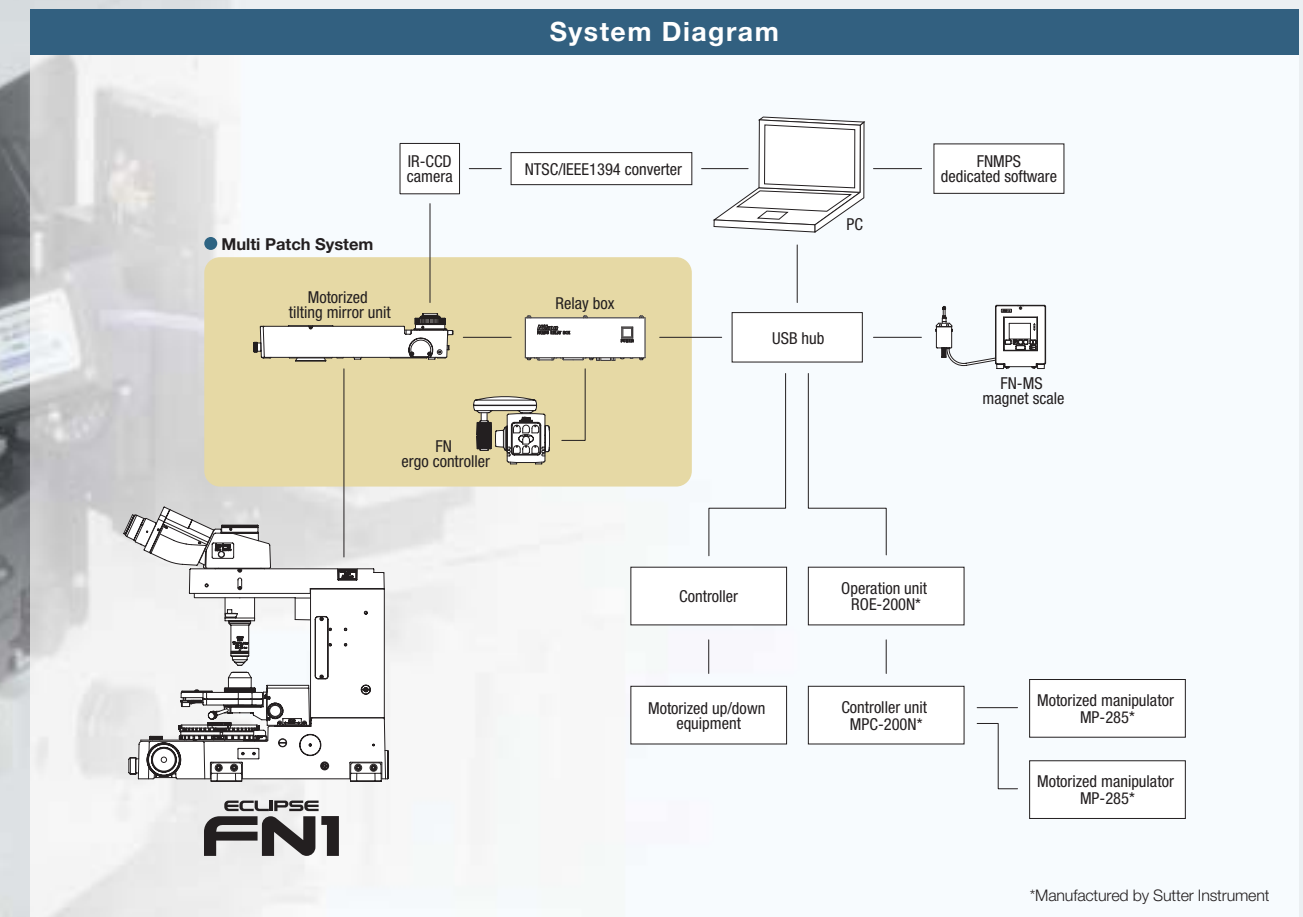

*Manufactured by Sutter Instrument

Notes: 1) Multi Patch System can be used only with the 16x objective. 2) Motorized magnification changeover is possible with rear port only. 3) Viewfield can not be moved at 0.35x.

Enhanced Noise Reduction and High Responsiveness to a Broad Range of Experimental Needs

Minimizing electronic noise

Nikon has succeeded in significantly reducing electrical noise by utilizing fiber illumination to bring light into the microscope from outside the cage. Noise can be dramatically reduced by connecting ground pins to all main parts of the microscope.

Ultimate vibration noise reduction

Nikon has achieved both improved rigidity and vibration resistance for the FN1 body by undertaking critical measurement and simulation analysis of its structure. Nikon has succeeded in suppressing the vibration generated when the nosepiece or the magnification module is switched.

Compatible with large specimens

The FN1 enables the microscope height to be raised by 10mm to 40mm by inserting up to four 10mm-thick spacers between the body and the arm. This is particularly advantageous for applications that require the observation of larger specimens such as intravital preps.



System Expansion

High-Resolution Confocal in-Vivo Imaging Systems

Multiphoton Confocal Microscope A1R MP

With high speed multiphoton confocal imaging up to 420fps with the resonant scanner, A1R MP visualizes dynamics deep within living organisms. Unmixing of probes with overlapping spectra is also possible. The high-sensitivity Non-Descanned Detector and CFI Apo 25xW MP objective with superb transmission and aberration correction enable sharp, high-contrast imaging.



FN1-A1R MP

Confocal Microscope C1 series

C1 series allows confocal patch-clamp imaging of deep areas of a specimen with excellent operability. Also, elimination of autofluorescence in vivo can be easily achieved.



FN1-C1

Accessories

Exclusive ITS-FN1 stage and mover

When Nikon and Narishige jointly developed the exclusive stage for the FN1, they placed priority on ease of use. The operator can easily sustain the stage in the horizontal position or switch the position of each pair of double magnet pillars and screwed pillars to suit individual experiments. With the microscope XY mover, it is possible to easily and precisely move to the region of interest by translating the whole microscope body in the X or Y axis direction.

Manufactured by Narishige Co., Ltd.



MT-1000 stage and mover

The pillars of this fixed stage, on which the manipulator and chamber are mounted, are designed as modular, making them compact and easy to customize. They can be freely placed around the mover, allowing effortless access to the microscope. By translating the microscope's optical system with the mover, observation and image acquisition of multiple specimen points are possible.

Manufactured by Sutter Instrument Company



Intensilight HG precentered fiber illuminator

The light source of this high-intensity 130W mercury illuminator for fluorescence observation can be placed away from the main equipment by liquid fiber connection, reducing influence of electric noise and heat exposure.



Mercury lamphouse for episcopic illumination

Episcopic illuminators

The D-FL Universal Epi-Fluorescence Attachment accepts 6 filter cubes. Its built-in noise terminator cuts stray light to achieve an exceptionally high signal:noise ratio. The J-FL Epi-Fluorescence Attachment accepts 4 filter cubes.



D-FL Universal Epi-Fluorescence Attachment



J-FL Epi-Fluorescence Attachment



LS-DWL-N diascopic fiber-optics illuminator

Accepts a 12V-100W halogen lamp. Light intensity can be finely tuned via the light control knob or external controller, which can also turn the lamp on/off.

Manufactured by SUMITA Optical Glass, Inc.



Precentered lamphouse for diascopic illumination

IR-DIC attachment

IR-DIC allows the visualization of minute structure deep within thick tissue of up to 300 or 400µm. Extremely high quality DIC images can be obtained using the IR polarizing set (850-950 nm) with a dedicated IR-CCD camera for image detection.



The IR-CCD camera in the photo is manufactured by Hamamatsu Photonics K. K.

Digital measuring unit (FN-MS Magnet Scale)

Accurate readout of the microscope body's Z axis moving distance at 1mm resolution is possible. The position of the manipulator can be adjusted with precision.



Motorized Multi Patch System

With the motorized tilting mirror unit, the field of view can be moved freely without moving the objective lens or specimen. Also, the motorized three-level magnification changeover function allows 5.6x, 32x and 64x image acquisition with the 16x objective only. The dedicated ergo controller enhances operability. It is possible to control the Sutter Instrument motorized manipulator to move the electrode automatically in conjunction with the viewfield changeover.



Sutter Instrument manipulators MPC-200N+ROE-200N

This jointly developed device by Nikon and Sutter Instrument, a manufacturer of manipulators for electrophysiological research used throughout the world, realizes stability and highly accurate and smooth operations. It can be controlled with Multi Patch System software.

Note: The conventional models MPC-200 and ROE-200 by Sutter Instrument can not be operated in conjunction with Multi Patch System.



FN-MT magnification variable turret

Offers flexibility in changing intermediate magnifications between 1x, 1.25x, 1.5x and 2x without moving the objective lens. Vibration-free zooming can be achieved with every FN1 objective lens.



LV-TT2 Tilting Trinocular Eyepiece Tube

It delivers erect images as opposed to the inverted images seen through ordinary eyepiece tubes. Its height-adjustable design ensures a comfortable viewing posture even when an intermediate module is mounted.



System Diagram

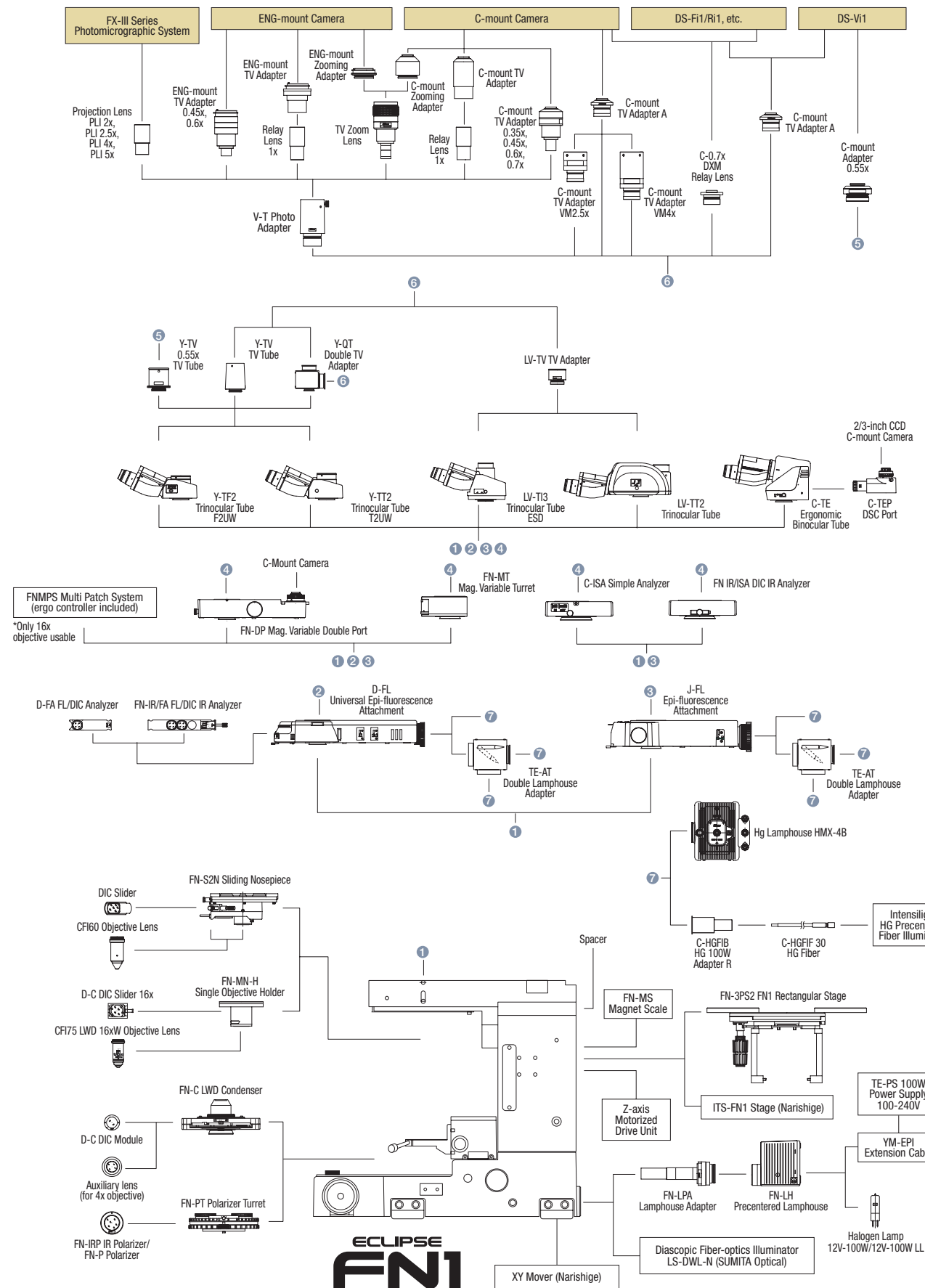

■ Specifications

Optical system	CFI60 and CFI75 infinity optical system
Main body	I-shaped, external power supply
Focusing	Via nosepiece up/down movement Manual coaxial coarse/fine focus knobs (on both sides)
Nosepiece	FN-S2N Sliding Nosepiece (for CFI60 objectives) Front/back 2-position; DIC prism attachable FN-MN-N Single Objective Holder (for CFI75 objective) 1-position; DIC prism attachable
Objectives	CFI Plan 4x NA: 0.10, W.D.: 30.0, with correction lens CFI Plan Fluor 10xW NA: 0.30, W.D.: 3.5 CFI75 LWD 16xW NA: 0.80, W.D.: 3.0 CFI Apo 40xW NIR NA: 0.80, W.D.: 3.5 CFI Apo 60xW NIR NA: 1.00, W.D.: 2.8 CFI Plan 100xW NA: 1.10, W.D.: 2.5, with correction ring
LWD condenser	Universal turret type NA: 0.78, W.D.: 7.2mm DIC and Oblique Light observations possible
Eyepiece	10x, F.O.V.: 22
Eyepiece tubes	C-TE Ergonomic Binocular Tube (Bino 100%, Bino : DSC port = 50 : 50) (DSC port cannot be used with variable magnification double port) Y-TF2 Trinocular Tube F2UW (Bino : Photo = 100 : 0, 0 : 100) Y-TT2 Trinocular Tube T2UW (Bino : Photo = 100 : 0, 20 : 80, 0 : 100) LV-TI3 Trinocular Tube ESD (Bino : Photo = 100 : 0, 0 : 100) LV-TT2 Tilting Trinocular Tube (Bino : Photo = 100 : 0, 20 : 80, 0 : 100)
Stage	FN-3PS2 FN1 Rectangular Stage (3-plate mechanical stage) Stroke: 30mm (X, Y)
Light source	Intensilight HG Precentered Fiber Illuminator: 12V-130W long-life mercury lamp Hg Lamphouse: 12V-100W mercury lamp FN-LH Precentered Lamphouse: 12V-100W long-life halogen lamp LS-DWL-N Optical Fiber Illuminator (Sumita Optical Glass, Inc.): 12V-100W halogen lamp
Operating conditions	Temperature: +10°C to +40°C Humidity: 85%RH max. (no condensation)
Weight (main body)	Approx. 12kg

■ Dimensional Diagram

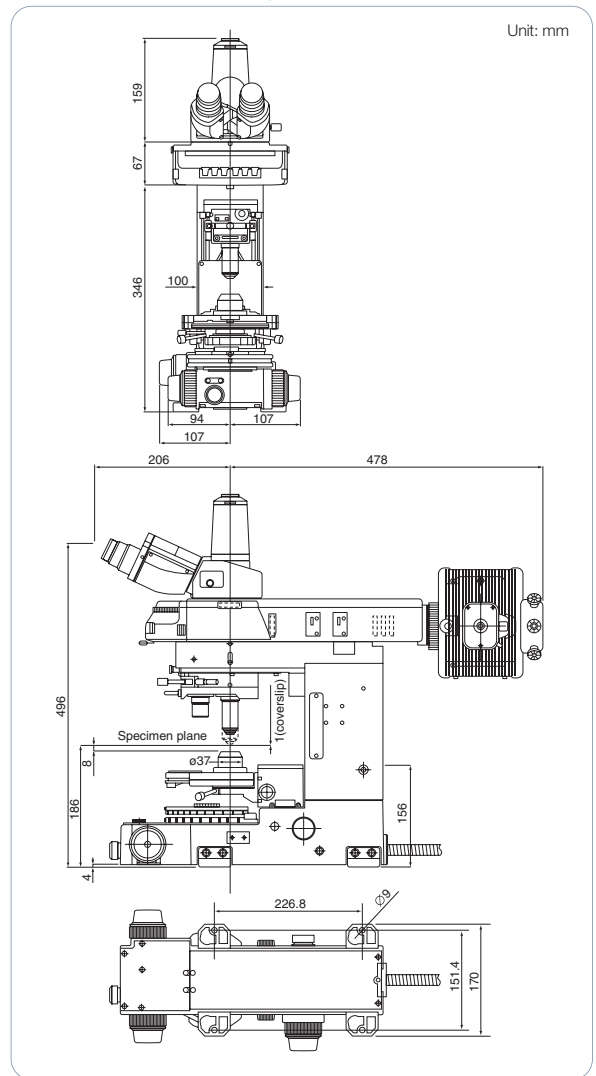

Specifications and equipment are subject to change without any notice or obligation on the part of the manufacturer. June 2010 ©2003-10 NIKON CORPORATION

 WARNING	TO ENSURE CORRECT USAGE, READ THE CORRESPONDING MANUALS CAREFULLY BEFORE USING YOUR EQUIPMENT.
--	--

Monitor images are simulated.
Company names and product names appearing in this brochure are their registered trademarks or trademarks.
N.B. Export of the products* in this brochure is controlled under the Japanese Foreign Exchange and Foreign Trade Law. Appropriate export procedure shall be required in case of export from Japan.
*Products: Hardware and its technical information (including software)



ISO 9001 Certified
NIKON CORPORATION
Instruments Company



ISO 14001 Certified
NIKON CORPORATION



NIKON CORPORATION

Shin-Yurakucho Bldg., 12-1, Yurakucho 1-chome, Chiyoda-ku, Tokyo 100-8331, Japan
phone: +81-3-3216-2375 fax: +81-3-3216-2385
<http://www.nikon.com/instruments/>

NIKON INSTRUMENTS INC.

1300 Walt Whitman Road, Melville, N.Y. 11747-3064, U.S.A.
phone: +1-631-547-8500; +1-800-52-NIKON (within the U.S.A. only)
fax: +1-631-547-0306
<http://www.nikoninstruments.com/>

NIKON INSTRUMENTS EUROPE B.V.

Laan van Kronenburg 2, 1183 AS Amstelveen, The Netherlands
phone: +31-20-44-96-300 fax: +31-20-44-96-298
<http://www.nikoninstruments.eu/>

NIKON INSTRUMENTS (SHANGHAI) CO., LTD.

CHINA phone: +86-21-5836-0050 fax: +86-21-5836-0030
(Beijing branch) phone: +86-10-5869-2255 fax: +86-10-5869-2277
(Guangzhou branch) phone: +86-20-3882-0552 fax: +86-20-3882-0580

NIKON SINGAPORE PTE LTD

SINGAPORE phone: +65-6559-3618 fax: +65-6559-3668

NIKON MALAYSIA SDN. BHD.

MALAYSIA phone: +60-3-7809-3688 fax: +60-3-7809-3633

NIKON INSTRUMENTS KOREA CO., LTD.

KOREA phone: +82-2-2186-8410 fax: +82-2-555-4415

NIKON CANADA INC.

CANADA phone: +1-905-602-9676 fax: +1-905-602-9953

NIKON FRANCE S.A.S.

FRANCE phone: +33-1-4516-45-16 fax: +33-1-4516-45-55

NIKON GMBH

GERMANY phone: +49-211-941-42-20 fax: +49-211-941-43-22

NIKON INSTRUMENTS S.p.A.

ITALY phone: +39-055-300-96-01 fax: +39-055-30-09-93

NIKON AG

SWITZERLAND phone: +41-43-277-28-67 fax: +41-43-277-28-61

NIKON UK LTD.

UNITED KINGDOM phone: +44-208-247-1717 fax: +44-208-541-4584

NIKON GMBH AUSTRIA

AUSTRIA phone: +43-1-972-6111-00 fax: +43-1-972-6111-40

NIKON BELUX

BELGIUM phone: +32-2-705-56-65 fax: +32-2-726-66-45